

Varenummer: 2310421530
Beskrivelse: E+G Pallås m/specialnøgle
CQT/A-FM-35-18-AE-VO

Mål

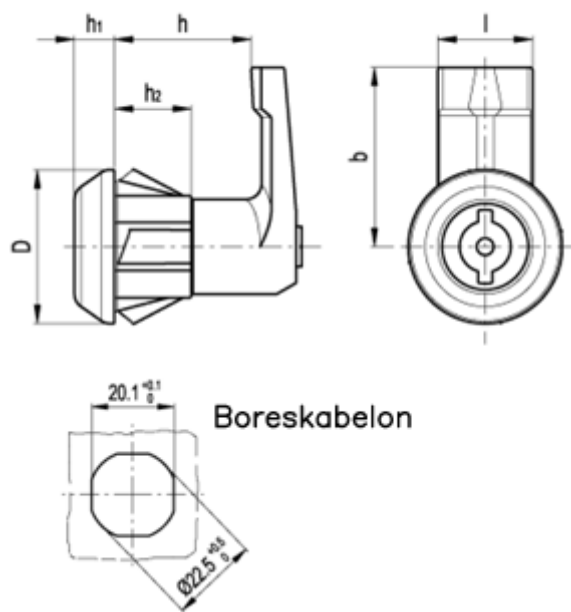

b	= 35
D	= 30
h	= 18
h1	= 8
h2	= 15
l	= 18.5
Vægt	= 19